

# High-pressure Connections

*Quick Connect Products for High-pressure  
Hydraulik Applications*

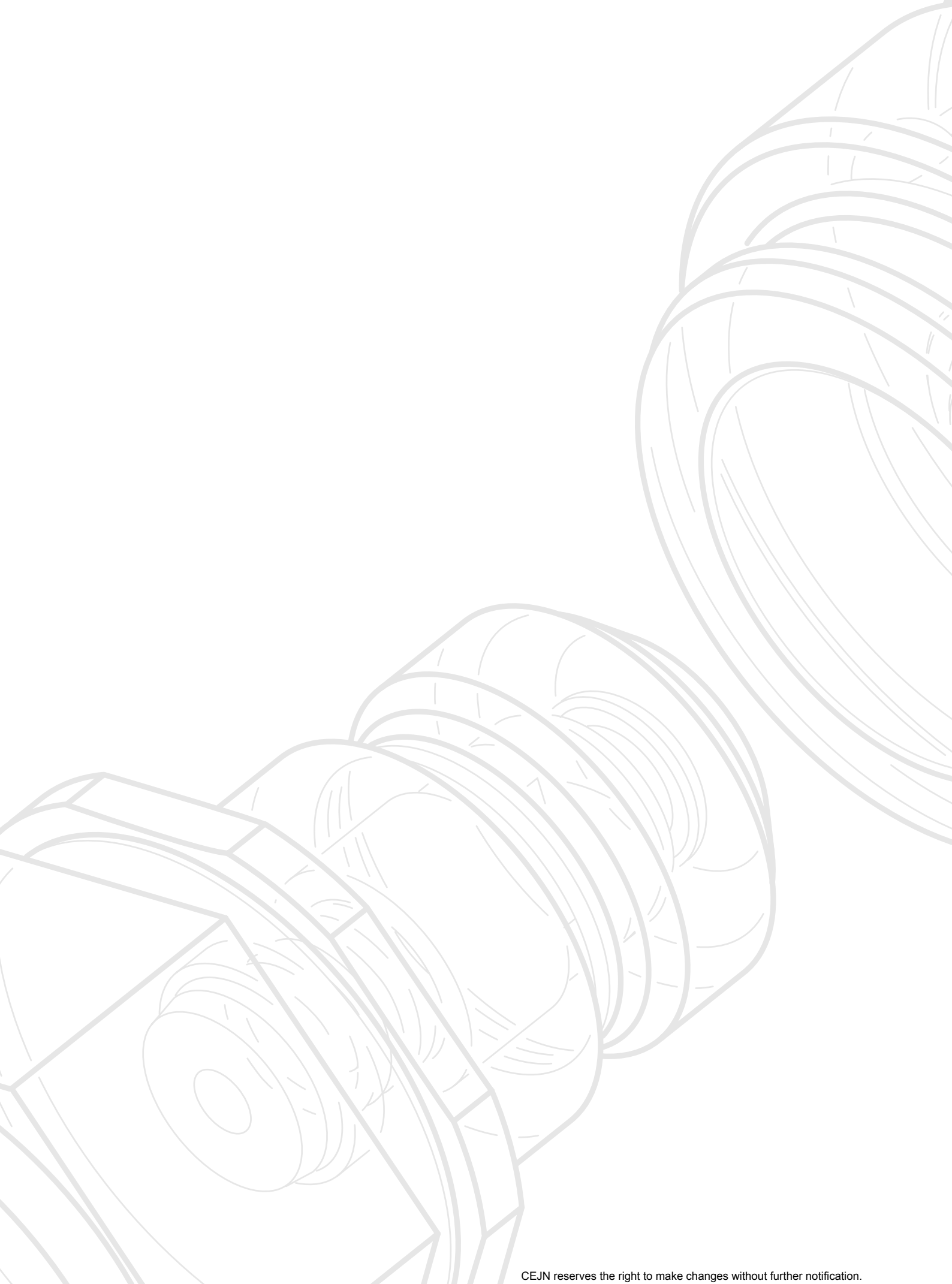



CEJN reserves the right to make changes without further notification.

For ultra-high pressure hydraulics, CEJN provides industry with the most complete line of high performance quick couplings.

## Content



<b>04</b>	<b>CEJN – A PARTNER TO COUNT ON WITH HIGH PRESSURE</b>
<b>06</b>	<b>CONSIDERATIONS WITH HIGH PRESSURES</b>
<b>08</b>	<b>FLAT-FACE COUPLINGS</b>
<b>10</b>	<b>PRODUCT RANGE</b>
<b>17</b>	<b>COMPLEMENTARY PRODUCTS</b>
<b>23</b>	<b>FACTS AND FIGURES</b>
<b>25</b>	<b>APPLICATION GUIDE</b>



## Low overall cost

*CEJN's ultra-high pressure hydraulics range gives you a wide choice of quick connect couplings with cost saving features, such as non-drip valves, dust caps, true "quick-connect" action; plus components made of hardened steel for dependable and repeated cycling, leading to long service life and lower maintenance costs.*



# CEJN – a partner to count on with high pressure



**CEJN Corporate Headquarter**  
CEJN AB  
Skövde, Sweden

**CEJN Sales Offices:**  
CEJN Norden AB  
Skövde, Sweden

CEJN Denmark Aps  
Esbjerg, Denmark

CEJN Product GmbH  
Troisdorf, Germany

CEJN France S.A.S  
Paris, France

CEJN AG  
Cham, Switzerland

CEJN Italy S.R.L.  
Milan, Italy

CEJN Ibérica S.L.  
Barcelona, Spain

CEJN Industrial Corporation  
Chicago, USA

CEJN Do Brasil LTDA  
Curitiba, Brazil

CEJN Australia PTY Limited  
Sydney, Australia

CEJN Japan Corporation  
Tokyo, Japan

CEJN Products Far East PTE LTD.  
Singapore City, Singapore

CEJN Products Far East CO, LTD.  
Seoul, Korea

CEJN Shanghai Fluid Systems CO LTD  
Shanghai, China

CEJN Products India Pvt. Ltd.  
Bangalore, India



ISO 9001 certified since 1995.  
ISO 14001 certified since 2006.

*CEJN is the world leader in quick connect coupling technology for high pressure hydraulics. With more than 50 years of experience in the industry, we have demonstrated our ability to provide solutions for the most demanding applications.*

Years of research and development have led to our vast product offering and leading position in non-drip quick couplings technology. Maximum flexibility, safety and reliability are the cornerstones that determine functional design and material selection. The result is a complete range of quick connect couplings especially designed for ultra-high pressure pumps, jacks, clamps, rescue equipment, torque and tensioning tools, diagnostics and other demanding applications.

## QUICK CONNECT FEATURES

Although other manufactures may offer couplings under the heading of “quick connect,” the ultra-high product range from CEJN is one of the few lines that include a truly quick to connect design; without threads that may bind or only partially connect. The safe, automatic locking system facilitates faster access, particularly suitable for confined areas.

## UNIQUE ADVANTAGES!

Designed with a non-drip interface, CEJN's series of ultra-high pressure couplings minimize both fluid spillage and air inclusion, saving clean-up costs and our environment, as well as ensuring proper system function.

In order to minimize unexpected downtime and increase reliability, all exposed components are manufactured with hardened steel to provide longer service life in rugged environments. Another advantage of the CEJN ultra-high series is the small envelope size, allowing easy installation and quick access to your fluid lines in confined spaces.

## DUST CAPS ARE STANDARD

All CEJN couplings are fitted with dust caps as standard. Because dirt and debris have known adverse effects on hydraulic systems, dust caps should always be used whenever the two halves are separated. Additionally, the two dust cap halves should be connected together whenever the coupling halves are connected; thereby preventing contamination from entering the dust caps. As standard practice, both the coupling and nipple halves should be thoroughly inspected and wiped clean prior to every connection.

## HIGH WORKING PRESSURE

With operating pressures as high as 300 MPa, the CEJN product range includes several couplings with a flat-face design, for ease of cleanliness. All coupling halves are designed to withstand the full working pressure while disconnected; however the nipples generally have a lower rated pressure when in the disconnect position.

CEJN's ultra-high pressure product range also includes accessories, such as hose assemblies, adapters, pressure gages and porting blocks.

## QUALITY

Before leaving CEJN's production facility, every coupling is tested multiple times to ensure functionality and performance. Each part is checked before, during and after assembly. Prior to shipment, each coupling is also function and leak tested to ensure that you receive a reliable, proven product.

## OTHER PRODUCTS FROM CEJN

CEJN's line of hydraulic products also includes quick connect couplings for low and intermediate pressure applications, as well as multi-couplings and auto-couplings. Contact CEJN for additional information and product bulletins.





# Considerations with high pressures

1 bar = 0.1 MPa  
1 bar = 0.987 atm  
1 bar = 14.5 PSI  
1 bar = 1.02 kg/cm<sup>2</sup>

1 MPa = 10 bar  
1 MPa = 9.87 atm  
1 MPa = 145 PSI  
1 MPa = 10.2 kg/cm<sup>2</sup>

1 atm = 0.101 MPa  
1 atm = 1.013 bar  
1 atm = 14.7 PSI  
1 atm = 1.03 kg/cm<sup>2</sup>

1 PSI = 0.007 MPa  
1 PSI = 0.068 atm  
1 PSI = 0.067 bar  
1 PSI = 0.07 kg/cm<sup>2</sup>

1 kg/cm<sup>2</sup> = 0.098 MPa  
1 kg/cm<sup>2</sup> = 0.968 atm  
1 kg/cm<sup>2</sup> = 98.067 PSI  
1 kg/cm<sup>2</sup> = 0.980 bar

## SEALING AT ULTRA-HIGH PRESSURES

CEJN recommends the use of metal-to-metal cone seats for ultra-high pressure hydraulic couplings. For pressures of 70 MPa and above, we have developed a unique seal that incorporates a 120° cone. The 120° cone allows for the seal to take place on a relatively small diameter, which minimizes strain on the threads. Additionally, the threads are straight, not tapered, thereby eliminating the risk of cracked threads under over-torque conditions. Because the CEJN connection has very good sealing properties at low tightening torque, the joint can be reassembled many times without damaging the sealing surfaces.

When using tapered threads, such as NPT or R, we recommend the use of a liquid or paste sealant - not thread tape (i.e. PTFE based tape), which may serve more as a lubricant and lead to cracked components. Thread tape may also become dislodged and find its way into hydraulic components, thereby causing damage or system malfunction.

Rubber-metal seals can be used when sealing parallel threads against boss or components with the appropriate sealing face. Rubber-metal seals should be avoided at pressures above 100 MPa.

## CONNECTING THE TWO HALVES

When connecting the two halves, always make sure that the locking sleeve moves forward to ensure a positive lock. Ultra-high pressure series couplings are not designed to be connected under pressure, as seal damage may occur.

## DUST CAPS

Extend product life by using dust caps. Dust or dirt on the coupling/nipple can easily enter the hydraulic system and in doing so impair the oil quality and system performance and in the worse possible scenario result in production downtime.

CEJN's dust caps can, as an extra safety precaution, be connected together to prevent dust from becoming attached to them when the nipple and coupling are connected.

Despite these precautions, you should still wipe off the coupling and nipple before connection.



# Flat-Face

## A one-hand-to-connect, non-drip coupling with built-in safety function

The one-hand-to-connect Flat-Face couplings have been developed to reliably meet the rigorous demands of ultra-high pressure hydraulic applications. Engineered to exacting

tolerances, using the most durable materials, CEJN ultra-high pressure couplings hold up where other couplings fail.

### One-hand-to-connect

The nipple is pushed into the coupling and is locked automatically. The locking sleeve does not need to be manually positioned.

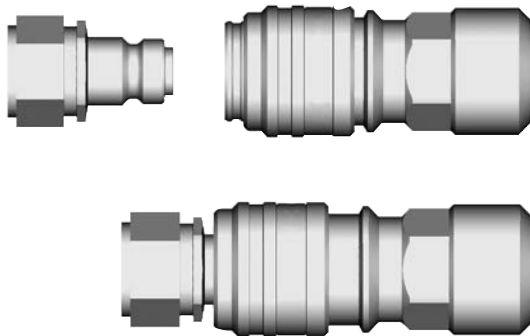

### Unique automatic safety function eliminates accidental disconnection

Turn the locking sleeve 30° and then pull backwards to release. The Flat-Face design ensures non-drip disconnection

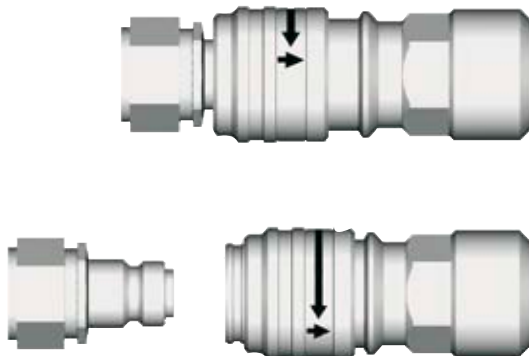

### Unique dust cap for nipples, with integrated pressure eliminator



Residual line pressure on the nipple side can sometimes make it difficult to connect the coupling, resulting in unnecessary downtime and frustration. By depressing the button on our new pressure eliminating dust cap, internal pressure is relieved, allowing the two halves to easily connect.





# Series 115 FF for rescue equipment

Series 115 in a Flat-Face design has a working pressure of 80 MPa. The series has a light-weight design with an aluminum back-part, which makes the series well adapted for applications where weight has a significance. Series 115 Flat-Face is primarily recommended for rescue equipment, torque tools and cable cutters.

The coupling can be connected to the standard 115 series nipple.

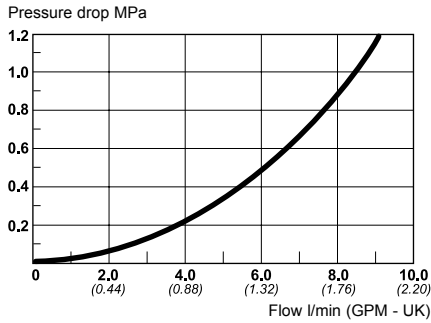

### Technical data

**Material:** Hardened, zinc chromate plated steel  
**Max. working pressure:** 80 MPa  
**Min. bursting pressure:** 280 MPa  
**Nominal flow diameter:** 2.5 mm (3/32")  
**Temperature range:** - 30°C - +100°C (-20°F - + 210°F)  
**Flow capacity at pressure drop 0.4 MPa:** 5.3 l/min (1.16 GPM UK)

The nipple should not be loaded while disconnected, see also page 26.

	Part No.	Connection	Length	Diameter	Hexagon	Con. stroke	Weight (g)	Rec. torque (Nm)	Rec. Sealing method	
COUPLINGS	Female thread									
		10 115 1200	G 1/4"	70.1	30.0	24	17.3	170	70-80	T

# Series 116 FF for industrial applications

Series 116 in a Flat-Face design has a working pressure of 150 MPa. Series 116 Flat-Face is primarily recommended for industrial applications, such as bolt tensioners, splitters and clamping tools.

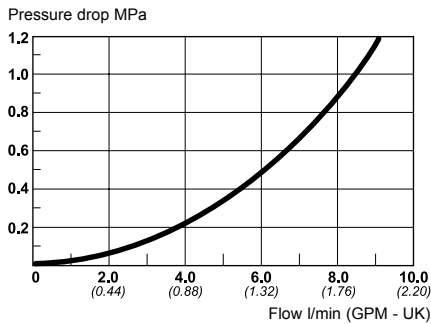

The coupling can be connected to the standard 116 series nipple.



### Technical data

**Material:** Hardened, zinc chromate plated steel  
**Max. working pressure:** 150 MPa. (3/8" -100 MPa)  
**Min. bursting pressure:** 300 MPa  
**Nominal flow diameter:** 2.5 mm (3/32")  
**Temperature range:** - 30°C - +100°C (-20°F - + 210°F)  
**Flow capacity at pressure drop 0.4 MPa:** 5.3 l/min (1.16 GPM UK)

The nipple should not be loaded while disconnected, see also page 26.

	Part No.	Connection	Length	Diameter	Hexagon	Con. stroke	Weight (g)	Rec. torque (Nm)	Rec. Sealing method	
COUPLINGS	Female thread									
		10 116 1219	G 1/4"	72.1	30.0	24	17.3	215	40-50	CMS
		10 116 1229	G 3/8"	72.6	30.0	24	17.3	225	70-80	T
		10 116 1419	NPT 1/4"	69.1	30.0	24	17.3	225	50-60	-
		10 116 1429	NPT 3/8"	70.6	30.0	24	17.3	220	70-80	-
Male thread										
	10 116 1269	G 1/4"	70.6	30.0	24	17.3	205	50-60	T (1*)	
	10 116 1279	G 3/8"	70.6	30.0	24	17.3	210	70-80	T	
	10 116 1469	NPT 1/4"	70.6	30.0	24	17.3	200	50-60	-	
	10 116 1479	NPT 3/8"	70.6	30.0	24	17.3	210	70-80	-	

### Dust cap in metal for Flat-Face range



For coupling, part no. 10 115 4100



For nipple, part no. 10 115 4101



For nipple, with pressure eliminator, part no. 10 115 4102

Thread connections are listed according to ISO Standards (see Page 23 for more information). All measurements are in mm (Dimension key, see page 25). Pressure conversion table, see page 24. Check with your local retailer for availability and prices.

# Series 115. 100 MPa.





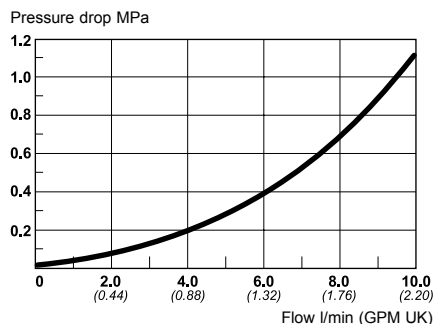

Series 115 is available in both standard and Flat-face designs (see page 9). The series is a CEJN original with extremely small outside dimensions. Non-drip connection and disconnection are standard on the CEJN high pressure range. All exposed components are made of zinc plated steel. The coupling is also available in a design with a safety ring for the locking sleeve to prevent accidental disconnection. Plastic dust caps are standard on both coupling and nipple (dust caps of aluminum can be ordered separately). The nipple is also available in a design with a hose rupture valve, part no. 10 115 6272. In the event of a ruptured hose the nipple closes and prevents the system from being drained of oil, which could have critical consequences for production and the environment. The hose rupture valve closes when the flow exceeds 13.0 liters/minute (2.86 GPM UK).



## Technical data

**Material:** Hardened, zinc chromate plated steel  
**Max. working pressure:** 100 MPa  
**Min. bursting pressure:** 260 MPa  
**Nominal flow diameter:** 2.5 mm (3/32")  
**Temperature range:** - 30°C - + 100°C (-20°F - + 210°F)  
**Flow capacity at pressure drop 0.4 MPa:** 6.0 l/min (1.32 GPM UK)

The nipple should not be loaded while disconnected, see also page 26.

	Part No.	Connection	Length	Diameter	Hexagon	Con. stroke	Weight (g)	Rec. torque (Nm)	Rec. Sealing method		
COUPLINGS	Female thread										
		10 115 1102	Rc 1/4"	59,3	28,0	24	18,3	170	50-60	-	
		10 115 1104	Rc 3/8"	60,8	28,0	24	18,3	165	70-80	-	
		10 115 1201	G 1/8"	53,8	28,0	24	18,3	155	40-50	T	
		10 115 1202	G 1/4"	61,3	28,0	24	18,3	165	40-50	CMS	
		10 115 1204	G 3/8"	63,3	28,0	24	18,3	170	70-80	T	
		10 115 1222	G 1/4"	61,3	28,0	24	18,3	170	40-50	CMS	
		safety lock									
		10 115 1401	NPT 1/8"	53,8	28,0	24	18,3	155	40-50	-	
		10 115 1402	NPT 1/4"	58,3	28,0	24	18,3	165	50-60	-	
		10 115 1404	NPT 3/8"	60,3	28,0	24	18,3	165	70-80	-	
		10 115 1422	NPT 1/4"	58,3	28,0	24	18,3	170	50-60	-	
		safety lock									
COUPLINGS	Male thread										
		10 115 1252	G 1/4"	61,3	28,0	24	18,3	151	40-50	T	
		10 115 1254	G 3/8"	60,8	28,0	24	18,3	155	70-80	T	
		10 115 1452	NPT 1/4"	61,8	28,0	24	18,3	150	50-60	-	
		10 115 1454	NPT 3/8"	62,3	28,0	24	18,3	155	70-80	-	
NIPPLES	Female thread										
		10 115 6102	Rc 1/4"	36,7	25,4	22	-	60	30-40	-	
		10 115 6104	Rc 3/8"	38,0	27,7	24	-	60	40-50	-	
		10 115 6201	G 1/8"	33,3	19,6	17	-	40	40-50	T	
		10 115 6202	G 1/4"	38,0	25,4	22	-	60	40-50	CMS	
		10 115 6204	G 3/8"	39,5	27,7	24	-	65	70-80	T	
		10 115 6401	NPT 1/8"	33,3	19,6	17	-	40	30-40	-	
		10 115 6402	NPT 1/4"	35,7	25,4	22	-	55	30-40	-	
		10 115 6404	NPT 3/8"	37,0	27,7	24	-	65	40-50	-	
	NIPPLES	Male thread									
			10 115 6152	R 1/4"	62,5	25,4	22	-	110	50-60	-
			10 115 6154	R 3/8"	63,0	25,4	22	-	115	70-80	-
			10 115 6212	G 1/4"	50,0	25,4	22	-	80	40-50	T
		10 115 6272	G 1/4"	52,0	25,4	22	-	85	40-50	T	
		hose rupture valve									
		10 115 6452	NPT 1/4"	61,5	25,4	22	-	105	50-60	-	
	10 115 6454	NPT 3/8"	62,1	25,4	22	-	115	70-80	-		



### Plastic dust cap for couplings

Part number 09 115 1002



### Plastic dust cap for nipples

Part number 09 115 1053

Thread connections are listed according to ISO Standards (see Page 23 for more information). All measurements are in mm (Dimension key, see page 25). Pressure conversion table, see page 24. Check with your local retailer for availability and prices.

# Series 116. 150 MPa.

Series 116 is available in both standard and Flat-face designs (see page 9). The series is a CEJN original with extremely small outside dimensions. Non-drip connection and disconnection are standard on the CEJN high pressure range. All exposed components are made of zinc plated steel. The coupling is also available in a design with a safety ring for the locking sleeve to prevent accidental disconnection. Plastic dust caps are standard on both coupling and nipple (dust caps of aluminum can be ordered separately). There is a coupling and nipple manufactured of stainless steel and chemically nickel-plated steel available for use in corrosive environments. There is a coupling with a 90°-connection angle for use in confined areas. The range is primarily recommended for cylinders, bolt tensioner tools, bearing pullers, etc.

## Technical data

**Material:** Hardened, zinc chromate plated steel

**Max. working pressure:** 150 MPa

**Min. bursting pressure:** 300 MPa



**Nominal flow diameter:** 2.5 mm (3/32")

**Temperature range:** - 30°C - + 100°C  
(-20°F - + 210°F)

**Flow capacity at pressure drop 0.4 MPa:**  
6.0 l/min (1.32 GPM UK)

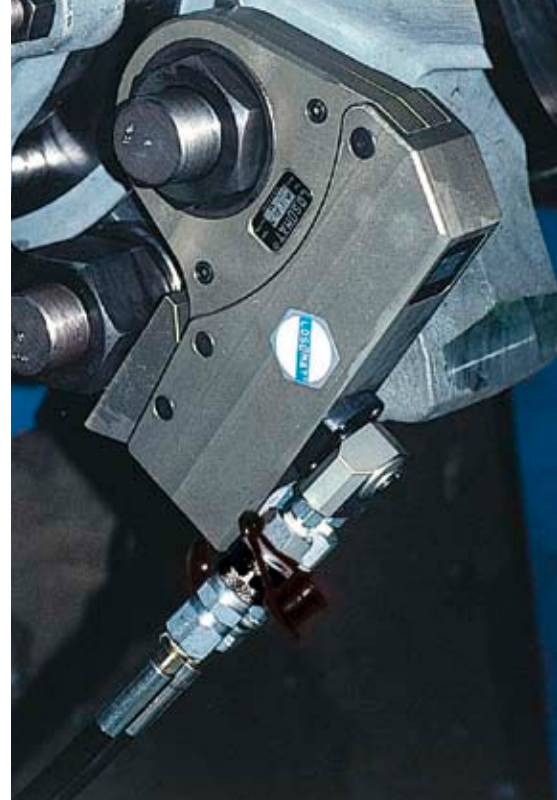
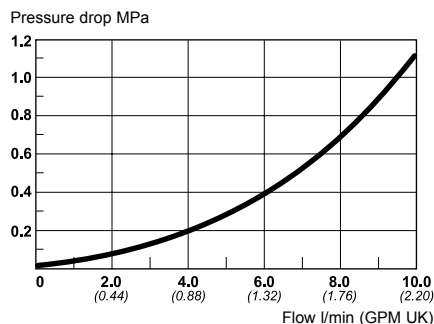
The nipple should not be loaded while disconnected, see also page 26.



	Part No.	Connection	Length	Diameter	Hexagon	Con. stroke	Weight (g)	Rec. torque (Nm)	Rec. Sealing method	
<b>COUPLINGS</b>	Female thread									
	10 116 1201	G 1/8"	53,8	28,0	24	18,3	155	40-50	T	
	10 116 1202	G 1/4"	61,3	28,0	24	18,3	165	40-50	CMS	
	10 116 1222	G 1/4"	61,3	28,0	24	18,3	170	40-50	CMS	
	safety lock									
		10 116 1230	G 1/4"	66,6	35	28	18,3	245	50-60	T (1*)
	angled connection									
	10 116 1246	G 1/4"	61,3	28,0	24	18,3	170	40-50	T	
safety lock stainless steel (chemical nickel plated steel locking sleeve)										
	10 116 1402	NPT 1/4"	58,3	28,0	24	18,3	165	50-60	-	
	10 116 1422	NPT 1/4"	58,3	28,0	24	18,3	170	50-60	-	
Safety lock										
<b>NIPPLES</b>	Female thread									
	10 116 6201	G 1/8"	33,3	19,6	17	-	40	40-50	T	
	10 116 6202	G 1/4"	38,0	25,4	22	-	60	40-50	CMS	
		10 116 6241	G 1/4"	38,0	25,4	22	-	60	40-50	CMS
	stainless steel valve (chemical nickel plated steel body)									
	10 116 6402	NPT 1/4"	35,7	25,4	22	-	55	30-40	-	
Male thread without valve										
	10 116 5252	G 1/4"	40,5	25,4	22	-	60	80-90	Washer (2*)	



**Plastic dust cap for couplings**

Part number 09 115 1004



**Plastic dust cap for nipples**

Part number 09 115 1055

Thread connections are listed according to ISO Standards (see Page 23 for more information). All measurements are in mm (Dimension key, see page 25). Pressure conversion table, see page 24. Check with your local retailer for availability and prices.



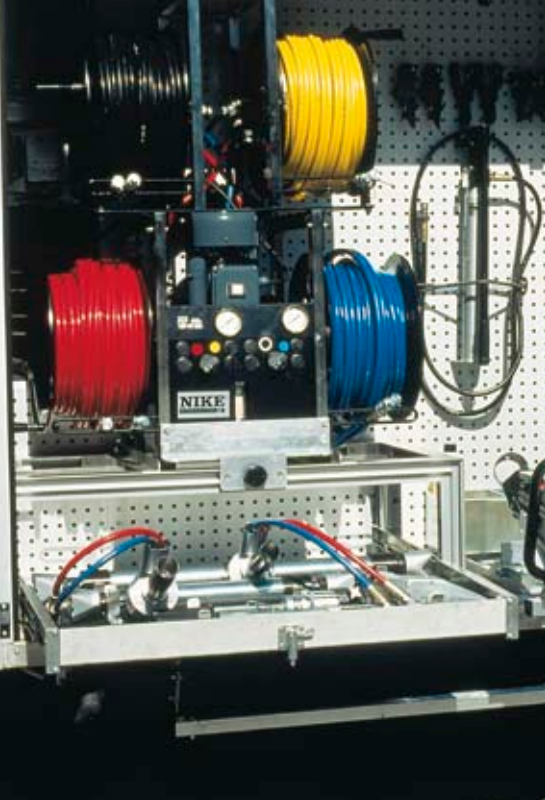

## Series 117. 100 MPa.

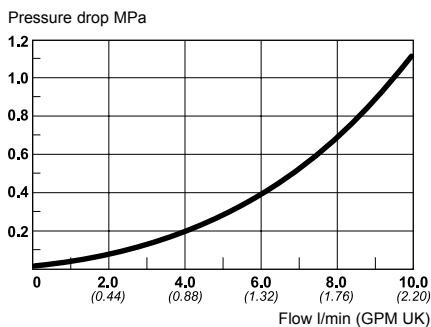

Series 117 is a sister coupling to series 115 and is used alongside the series 115 in applications where the systems must not, under any circumstances, be interconnected. 115 and 117 offer the same performance and qualities, but cannot be connected with one another, which makes them an unbeatable combination for rescue tools, etc. All exposed components are made of zinc plated steel. Plastic dust caps are standard on both coupling and nipple.



### Technical data

**Material:** Hardened, zinc chromate plated steel  
**Max. working pressure:** 100 MPa  
**Min. bursting pressure:** 260 MPa  
**Nominal flow diameter:** 2.5 mm (3/32")  
**Temperature range:** - 30°C - + 100°C (-20°F - + 210°F)  
**Flow capacity at pressure drop 0.4 MPa:** 6.0 l/min (1.32 GPM UK)

The nipple should not be loaded while disconnected, see also page 26.

	Part No.	Connection	Length	Diameter	Hexagon	Con. stroke	Weight (g)	Rec. torque (Nm)	Rec. Sealing method	
<b>COUPLINGS</b>	Female thread									
		10 117 1202	G 1/4"	61.3	28.0	24	18.3	165	40-50	CMS
		10 117 1232	G 1/4"	61.3	28.0	24	18.3	170	40-50	CMS
		10 117 1404	NPT 3/8"	60.3	28.0	24	18.3	165	70-80	-
		10 117 1434	NPT 3/8"	60.3	28.0	24	18.3	170	70-80	-
	Male thread									
		10 117 1254	G 3/8"	60.8	28.0	24	18.3	155	70-80	T
		10 117 1454	NPT 3/8"	62.3	28.0	24	18.3	155	70-80	-
<b>NIPPLES</b>	Female thread									
		10 117 6202	G 1/4"	38.0	25.4	22	18.3	60	40-50	CMS
		10 117 6404	NPT 3/8"	37.0	27.7	24	18.3	65	40-50	-



**Plastic dust cap for couplings**

Part number 09 115 1004



**Plastic dust cap for nipples**

Part number 09 115 1055

Thread connections are listed according to ISO Standards (see Page 23 for more information). All measurements are in mm (Dimension key, see page 25). Pressure conversion table, see page 24. Check with your local retailer for availability and prices.

# Series 218. 100 MPa.

The series 218 is a CEJN original that, despite very small outside dimensions, gives an extremely high flow. Both the patented sealing design and non-drip connection and disconnection are standard on CEJN's high pressure range. The coupling also has a safety ring for the locking sleeve to prevent accidental disconnection. Plastic dust caps are standard on both coupling and nipple. The series is an allround coupling that works well in most applications, even if it is mainly recommended where large flow rates are required.

## Technical data

**Material:** Hardened, zinc chromate plated steel

**Max. working pressure:** 100 MPa

**Min. bursting pressure:** 280 MPa

**Nominal flow diameter:** 4.5 mm (11/64")



**Temperature range:** - 30°C - + 100°C  
(-20°F - + 210°F)

**Flow capacity at pressure drop 0.4 MPa:**

15.0 l/min (3.30 GPM UK)

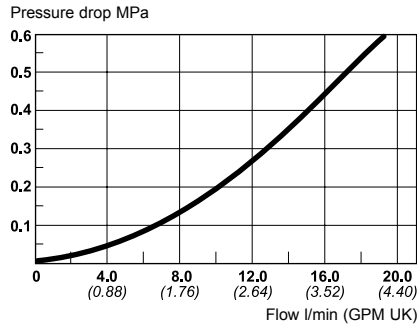
The nipple should not be loaded while disconnected, see also page 26.



	Part No.	Connection	Length	Diameter	Hexagon	Con. stroke	Weight (g)	Rec. torque (Nm)	Rec. Sealing method	
<b>COUPLINGS</b>	Female thread									
		10 218 1234	G 3/8"	73,4	34,6	30	20,1	340	70-80	T
		10 218 1434	NPT 3/8"	73,4	34,6	30	20,1	330	70-80	-
<b>NIPPLES</b>	Female thread									
		10 218 6204	G 3/8"	50,5	27,7	24	-	115	70-80	T
		10 218 6404	NPT 3/8"	49,0	27,7	24	-	110	40-50	-



**Plastic dust cap for couplings**

Part number 09 218 1000



**Plastic dust cap for nipples**

Part number 09 218 1050

Thread connections are listed according to ISO Standards (see Page 23 for more information). All measurements are in mm (Dimension key, see page 25). Pressure conversion table, see page 24. Check with your local retailer for availability and prices.



## Series 125. 200 MPa.

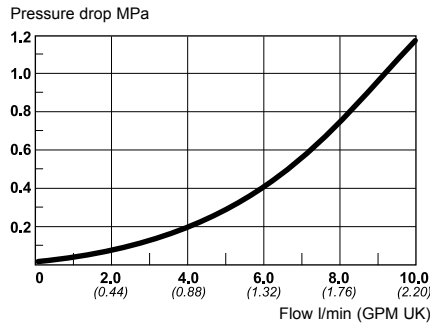

Series 125 is a CEJN original with extremely small outside dimensions and a patented seal design. Non-drip connection and disconnection are standard on the CEJN high pressure range. All exposed components are made of zinc plated steel. Plastic dust caps are standard on both coupling and nipple. The range is primarily recommended for nut runners, bearing pullers, etc.



### Technical data

**Material:** Hardened, zinc chromate plated steel  
**Max. working pressure:** 200 MPa  
**Min. bursting pressure:** 400 MPa  
**Nominal flow diameter:** 2.5 mm (3/32")  
**Temperature range:** - 30°C - + 100°C (-20°F - + 210°F)  
**Flow capacity at pressure drop 0.4 MPa:** 5.8 l/min (1.28 GPM UK)

The nipple should not be loaded while disconnected. See also page 26.

	Part No.	Connection	Length	Diameter	Hexagon	Con. stroke	Weight (g)	Rec. torque (Nm)	Rec. Sealing method	
<b>COUPLINGS</b>	Female thread									
	10 125 1202	G 1/4"	64.3	30.0	24	20.2	210	40-50	CMS	
<b>NIPPLES</b>	Female thread									
		10 125 6202	G 1/4"	38.0	25.4	22	-	60	40-50	CMS
	Male thread without valve									
	10 125 5252	G 1/4"	42.5	25.4	22	-	65	100-110	Washer (2*)	



**Plastic dust cap for couplings**

Part number 09 115 1004



**Plastic dust cap for nipples**

Part number 09 115 1055

Thread connections are listed according to ISO Standards (see Page 23 for more information). All measurements are in mm (Dimension key, see page 25). Pressure conversion table, see page 24. Check with your local retailer for availability and prices.



# Series 135. 300 MPa.

Series 135 is a CEJN original for extremely high working pressure, 300 MPa. The series also withstands pressure up to 300 MPa while disconnected (applies to the coupling and nipple). Non-drip connection and disconnection are standard on the CEJN high pressure range. The coupling also has a safety ring for the locking sleeve to prevent accidental disconnection. Plastic dust caps are standard on both coupling and nipple. Swiveling can cause wear damage over time why the nipple is available in both swivel and non-swivel designs. Each coupling and nipple are pressure tested up to full working pressure before delivery. The series makes it possible to connect pumps and accessories faster, safer and more conveniently, even at extreme pressure. The series is in the first place recommended for bearing pullers, splitters and hydraulic test installations.

## Technical data

**Material:** Hardened black finish steel

**Max. working pressure:** 300 MPa

**Min. bursting pressure:** 600 MPa

**Nominal flow diameter:** 2.5 mm (3/32")

**Temperature range:** -20°C - +80°C

(0°F - +175°F)

**Flow capacity at pressure drop 0.4 MPa:**



4.6 l/min (1.01 GPM UK)

**Max. recommended number of pressure cycles**

with nipple 10 135 6505: 1000

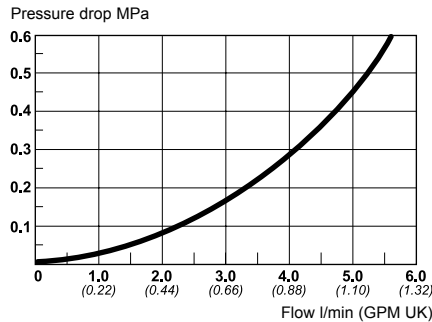
with nipple 10 135 6506: 5000



COUPLINGS	female thread with 60° sealing cone (interchangeable with both nipple designs)	Part No.	Connection	Length	Diameter	Key handle	Con. stroke	Weight (g)	Rec. torque (Nm)	Rec. Sealing method	
			10 135 1505	M16x1.5	64.0	30.0	22	20.6	210	40-50	
										<b>Max. working pressure:</b> 300 MPa <b>Min. bursting pressure:</b> 600 MPa <b>Temperature range:</b> -20° C - +80° C (0°F - +175°F) <b>Max. no. of pressure cycles connected with:</b> nipple 10 135 6505: 1000 nipple 10 135 6506: 5000	<b>Seal material:</b> Nitrile rubber <b>Flow diameter:</b> 2.5 mm (3/32")
NIPPLES	Female thread with 60° sealing cone Standard design	Part No.	Connection	Length	Diameter	Key handle	Con. stroke	Weight (g)	Rec. torque (Nm)	Rec. Sealing method	
		10 135 6505	M16x1.5	55.3	25.0	22	-	125	40-50		
										<b>Max. working pressure:</b> 300 MPa <b>Min. bursting pressure:</b> 600 MPa <b>Temperature range:</b> -20° C - +80° C (0°F - +175°F) <b>Max. no. of pressure cycles connected (to max. working pressure):</b> 1000	<b>Seal material:</b> Nitrile rubber <b>Flow diameter:</b> 2.5 mm (3/32")
	Female thread with 60° sealing cone Non-swivel design	Part No.	Connection	Length	Diameter	Key handle	Con. stroke	Weight (g)	Rec. torque (Nm)	Rec. Sealing method	
		10 135 6506	M16x1.5	55.3	25.0	22	-	125	40-50		
										<b>Max. working pressure:</b> 300 MPa <b>Min. bursting pressure:</b> 600 MPa <b>Temperature range:</b> -20° C - +80° C (0°F - +175°F) <b>Max. no. of pressure cycles connected (to max. working pressure):</b> 5000 <b>Non-swivel model. Six optional positions are possible when connecting.</b>	<b>Seal material:</b> Nitrile rubber <b>Flow diameter:</b> 2.5 mm (3/32")



**Plastic dust cap for couplings**

Part number 09 140 1000



**Plastic dust cap for nipples**

Part number 09 140 1050

Thread connections are listed according to ISO Standards (see Page 23 for more information). All measurements are in mm (Dimension key, see page 25). Pressure conversion table, see page 24. Check with your local retailer for availability and prices.



# Series 230. 70 MPa. Screw-to-connect couplings.

Series 230 is a screw-to-connect series and a good complement to CEJN's large range of quick connect couplings. The series is also characterised by CEJN's quality approach and has a high flow rate capacity. The series can be connected under pressure and is interchangeable with most screw-to-connect couplings. Hand pumps, cylinders and jacks are just a few examples of application areas.

## Technical data

**Material, coupling:** Zinc plated steel

**Material, dust cap:** Steel

**Seal:** Nitrile NBR

**Max. working pressure:** 70 MPa

**Min. bursting pressure:**

Connected: 1/4" 220 MPa

3/8" 185 MPa

Coupling disconnected: 1/4" 180 MPa

3/8" 185 MPa

Nipple disconnected: 1/4" 149 MPa

3/8" 150 MPa

**Nominal flow diameter:** 1/4" 5 mm, 3/8" 7 mm

**Flow capacity at pressure drop 0.4 MPa:**



1/4" 16.1 l/min (3.54 GPM UK)

3/8" 21.2 l/min (4.64 GPM UK)

**Temperature range:** -30°C - +100°C

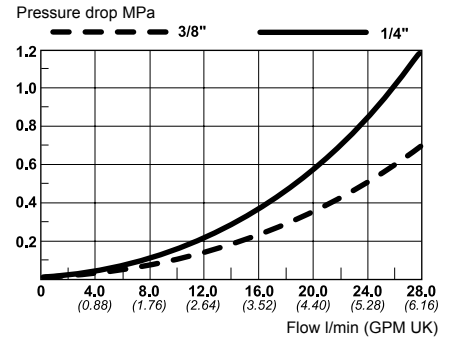
(-20°F - + 210°F)



	Part No.	Connection	Length	Diameter	Hexagon	Con. stroke	Weight (g)	Rec. torque (Nm)	Rec. Sealing method	
<b>COUPLINGS</b>	Male thread									
		10 230 1452	NPT 1/4"	60.8	28.0	22	18.8	120	50-60	-
		10 230 1484	NPT 3/8"	72.3	35.0	24	25.4	220	70-80	-
<b>NIPPLES</b>	Female thread									
		10 230 6402	NPT 1/4"	32.5	28.0	19	-	75	50-60	-
		10 230 6434	NPT 3/8"	40.0	35.0	32	-	140	70-80	-

## Dust caps



**10 230 4101**  
For 1/4" coupling 10 230 1452



**10 230 4100**  
For 1/4" nipple 10 230 6402



**10 230 4103**  
For 3/8" coupling 10 230 1484



**10 230 4102**  
For 3/8" nipple 10 230 6434

Thread connections are listed according to ISO Standards (see Page 23 for more information). All measurements are in mm (Dimension key, see page 25). Pressure conversion table, see page 24. Check with your local retailer for availability and prices.

# Pre-Assembled Hose Kits

## PRESSURE TESTED AND READY TO USE



The range of CEJN high-pressure hose is like the rest of the CEJN product range a testament to quality and performance. Only the best is sold under the CEJN brand and this range is clearly part of that tradition. The range contains four hoses with different pressure ratings up to 250 MPa. With a large variety of fittings to choose from, hose kits can be assembled to meet almost all requests.

### Advantages!

- Ultra-high working pressures
- Maintained flexibility through entire service life
- Low volumetric expansion
- Smooth inner bores
- Kink-resistant steel-reinforced construction
- Abrasion-resistant covers
- Small outside diameter
- Superior chemical resistance

### Benefits!

The CEJN High-Pressure hose is a spiralized steel reinforced polymer hose that picks up where conventional product capabilities stop. It gives you ultra-high working pressure with maintained flexibility through entire life. Its low volumetric expansion gives fast response time in hydraulic systems while the smooth inner bores provide a minimized pressure drop. A long-lasting service time and extended hose life in even the toughest applications is a result of the kink-resistant steel-reinforced construction, abrasion-resistant covers and a superior chemical resistance. The small outside diameter makes the hose ideal for tight routing.

Hose	CEJN 700	CEJN 1000	CEJN 1800	CEJN 2500
<b>Part no.:</b>				
<b>Hose</b>	19 951 0701 (Red)	19 951 1001 (Black)	19 951 1801 (Blue)	19 951 2501 (Red)
<b>Hose – Twin design</b>	19 951 0710 (Red/Yellow)	19 951 1010 (Red/Blue)	–	–
<b>Design:</b>	Inner tube of polyamide (PA), 2 spiral layers of high tensile steel wire, 2 open spiral synthetic fibre, outer sheath of polyurethane (PUR)	Inner tube of polyamide (PA), 4 layers of spiral wound steel wire, outer sheath of polyurethane (PUR)	Inner tube of polyoxymethylene (POM), 4 spiral layers of high tensile steel wire, outer sheath of polyimide (PA)	Inner tube of polyoxymethylene (POM), 6 spiral layers of high tensile steel wire, outer sheath of polyimide (PA)
<b>Max. working pressure:</b>	70 MPa (10,150 PSI)	100 MPa (14,500 PSI)	180 MPa (26,100 PSI)	250 MPa (36,250 PSI)
<b>Min. burst pressure:</b>	186 MPa (26,970 PSI)	320 MPa (46,600 PSI)	450 MPa (65,250 PSI)	625 MPa (90,620 PSI)
<b>I.D. x O.D.:</b>	6.3 x 12.4 mm	6.3 x 13.3 mm	4.7 x 11.5 mm	4.7 x 13.0 mm
<b>Min. bend radius:</b>	70 mm	80 mm	130 mm	175 mm
<b>Weight:</b>	190 g/m	305 g/m	280 g/m	410 g/m
<b>Temperature range:</b>	-40°C to +100°C (-40°F to +212°F)	-40°C to +100°C (-40°F to +212°F)	-40°C to +100°C (-40°F to +212°F)	-40°C to +100°C (-40°F to +212°F)
<b>Other information:</b>	<i>Other colors upon request</i>			

Thread connections are listed according to ISO Standards (see page 23 for more information). All measurements are in mm (Dimension key, see page 25). Pressure conversion table, see page 24. Check with your local retailer for availability and prices.



# Hose kits to fit your needs

## Opportunities!

Each hose kit is assembled to your order. The hose can be cut in any length and assembled with a large variety of fittings and couplings/nipples. CEJN's series of high performance high-pressure hydraulic couplings are an excellent complement and can be included in any hose kit. Before delivery each kit is pressure tested for safety and performance. When delivered the kits are ready to be used without further assembly, tests or checks, making it a perfect choice to save time and cost. Four hoses with different pressure ratings, a large range of fittings and several high performing couplings make CEJN High-pressure hose kits a perfect choice for most applications. Below is a condensed list of hose and fittings, more options are available on request.

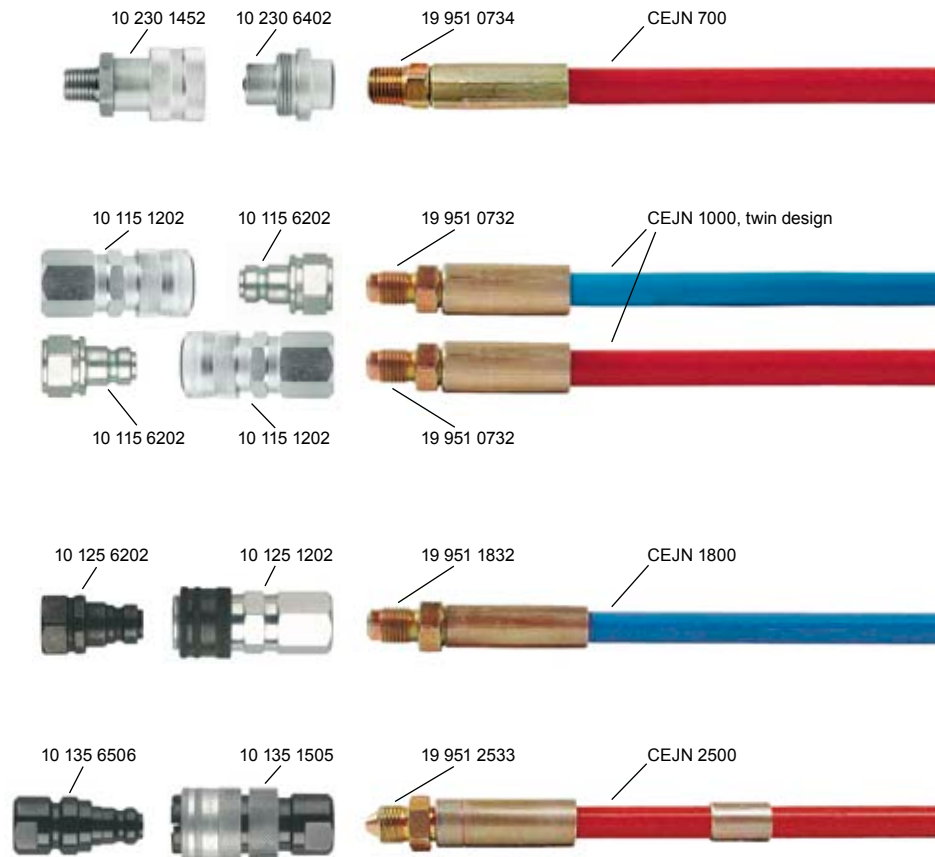

End connections, Part no.	70/100 MPa	180 MPa	250 MPa
G 1/4" male with 60° int. sealing cone + recess for Tredo ring	19 951 0730	19 951 1830	–
G 1/4" male with recess for USIT ring	19 951 0731	–	–
G 1/4" male with 120° ext. sealing cone (CMS)	19 951 0732	19 951 1832	19 951 2530
G 1/4" male flat end for copper washer (*with recess for USIT ring)	19 951 0733	19 951 1831 *	19 951 2534
1/4" NPT male	19 951 0734	–	–
3/8" NPT male	19 951 0735	–	–
3/8" NPT female	19 951 0740	–	–
R 1/4" male	19 951 0741	–	–
R 3/8" male	19 951 0736	–	–
Sealing head (60°) + G 1/4" female swivel nut	19 951 0737	19 951 1833	19 951 2531
M16 x 1.5 male with 60° ext. cone	–	–	19 951 2533
Sealing head (60°) + M14 x 1.5 female swivel nut	19 951 0738	–	–
59° ext. sealing cone + 9/16"-18 UNF female swivel nut	–	–	19 951 2532
24° ext. sealing cone with O-ring + M18 x 1.5 female swivel nut	19 951 0739	–	–
Kink-protection spring	19 951 1080	–	–
Clamb for twin-hose	19 951 1081	–	–
Protection hose PVC	–	19 951 1880	–

Accessories	Part no.
Copper washer	09 950 4600
Tredo ring (rubber/metal seal) for G 1/4"	19 950 0062
Tredo ring (rubber/metal seal) for G 1/4", high strength steel	19 950 0083
USIT ring (rubber/metal seal) for G 1/4"	19 950 0084

Thread connections are listed according to ISO Standards (see page 23 for more information). All measurements are in mm (Dimension key, see page 25). Pressure conversion table, see page 24. Check with your local retailer for availability and prices.

# Series 940. Pressure gauges.



CEJN's range comprises of both bottom and panel mounted pressure gauges in models up to 2000 bar (200 MPa). All models are glycerine filled for improved performance and long life. The gauges are made of stainless steel, which means they can be used in dirty and rugged environments. The pressure gauges can be connected by means of a porting block (see page 22).

## Technical data

### Max. recommended working pressure:

75% of the full scale range.

### Material:

- Stainless steel AISI 316 and AISI 304.
- Dial face of aluminium with black graduations.
- Pointer of aluminium or stainless steel.
- Gasket of polychloroprene.
- Window of plexiglass.

### Units:

bar and PSI.

### Protection class:

IP 65.

### Liquid filled with 98% glycerine.

### Accuracy:

- Ø 63 mm +/- 1.6% of full scale.
- Ø 100 and 160 mm +/- 1% of full scale.

### Temperature range:

+15° C - +65° C (+60° F - +150° F).

### Miscellaneous:

Ø 100 and 160 mm manufactured in accordance with EN 837-1.

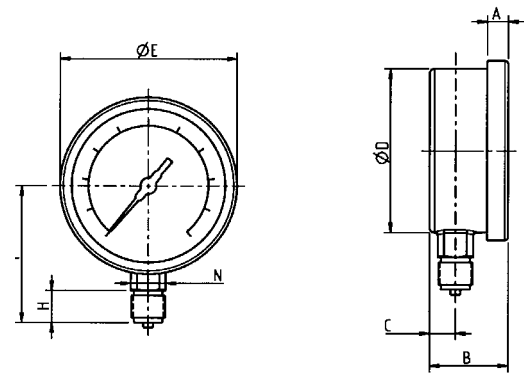

Bottom connection.  
Ø 63 mm. Ø 100 mm. Ø 160 mm.

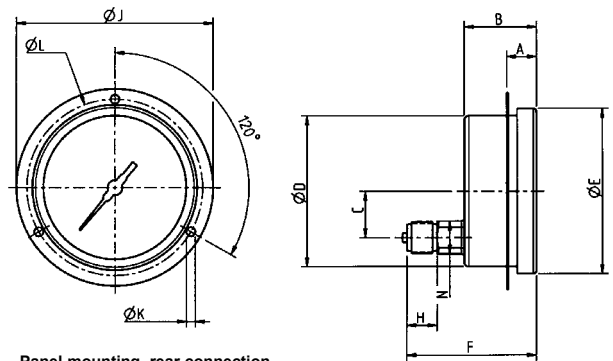

Panel mounting, rear connection.  
Ø 63 mm (connection in the center of the housing).  
Ø 100 mm. Ø 160 mm.

		Part No.	Connection	Scale max. work pressure bar (PSI)	Dimensions mm										
					A	B	C	D	E	F	H	J	K	L	N
Ø 63 MM	Bottom connection Male thread	19 940 2120	G 1/4"	1000 (14 500)	22	42	9,5	62	64	52	13	-	-	-	14
		19 940 2121	NPT 1/4"	1000 (14 500)	22	42	9,5	62	64	52	13	-	-	-	14
Ø 63 MM	Panel mounting Male thread	19 940 2320	G 1/4"	1000 (14 500)	5	32	0	62	68	55	13	85	3,6	75	14
		19 940 2321	NPT 1/4"	1000 (14 500)	5	32	0	62	68	55	13	85	3,6	75	14
Ø 100 MM	Bottom connection Male thread	19 940 3120	G 1/2"	1000 (14 500)	17,5	49,5	15,5	99	101	87	20	-	-	-	22
		19 940 3140	NPT 1/2"	1000 (14 500)	17,5	49,5	15,5	99	101	87	20	-	-	-	22
		19 940 3121	G 1/2"	1600 (23 200)	17,5	49,5	15,5	99	101	87	20	-	-	-	22
		19 940 3122	G 1/2"	2060 (29 870)	17,5	49,5	15,5	99	101	87	20	-	-	-	22
Ø 100 MM	Panel mounting Male thread	19 940 3320	G 1/2"	1000 (14 500)	6	54	30	101	101	85,5	20	132	4,8	116	22
		19 940 3321	G 1/2"	1600 (23 200)	6	54	30	101	101	85,5	20	132	4,8	116	22
		19 940 3322	G 1/2"	2060 (29 870)	6	54	30	101	101	85,5	20	132	4,8	116	22
Ø 160 MM	Bottom connection Male thread	19 940 4120	G 1/2"	1000 (14 500)	17,5	49,5	15,5	159	161	118	20	-	-	-	22
		19 940 4121	G 1/2"	1600 (23 200)	17,5	49,5	15,5	159	161	118	20	-	-	-	22
		19 940 4122	G 1/2"	2060 (29 870)	17,5	49,5	15,5	159	161	118	20	-	-	-	22
Ø 160 MM	Panel mounting Male thread	19 940 4320	G 1/2"	1000 (14 500)	10	49,5	50	159	161	82	20	196	5,8	178*	22
		19 940 4321	G 1/2"	1600 (23 200)	10	49,5	50	159	161	82	20	196	5,8	178*	22
		19 940 4322	G 1/2"	2060 (29 870)	10	49,5	50	159	161	82	20	196	5,8	178*	22

Thread connections are listed according to ISO Standards (see page 23 for more information). All measurements are in mm (Dimension key, see page 25). Pressure conversion table, see page 24. Check with your local retailer for availability and prices.

\* not in accordance with EN 837-1

# Series 950. Adapters.

## 100-300 MPa

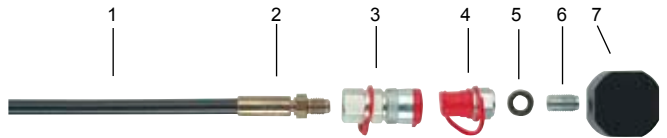

- 1. Hose type CEJN 1000
- 2. 1/4" G male thread with 120° ext. sealing cone (CMS) part no. 19 951 0732
- 3. Coupling part no. 10.115 1202
- 4. Nipple part no. 10 115 6202
- 5. Rubber metal seal part no. 19 950 0062
- 6. Adapter part no. 19 950 0015
- 7. Porting block part no. 19 950 1680

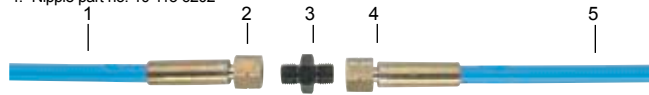

- 1. Hose type CEJN 1800
- 2. 1/4" G thread, female swivel with 24°/60° ext. cone part no. 19 951 1833
- 3. Adapter part no. 19 950 1622
- 4. 1/4" G thread, female swivel with 24°/60° ext. cone part no. 19 951 1833
- 5. Hose type CEJN 1800

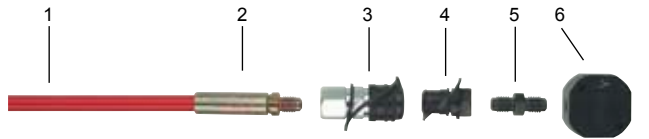

- 1. Hose type CEJN 2500
- 2. 1/4" G male thread with 120° ext. sealing cone CEJN metal seal part no. 19 951 2530
- 3. Coupling part no. 10.125 1202
- 4. Nipple part no. 10.125 6202
- 5. Adapter part no. 19 950 1601
- 6. Porting block part no. 19 950 1680

A safe and trouble free connection is essential in all situations. CEJN's extensive range of adapters cover a very wide connection range suitable for most couplings and hoses. All adapters are manufactured of black-zinc plated steel. Working pressure varies between 100 MPa and 300 MPa, see product table for data on respective adapters.

Part No. Max. Rec. Working pressure.	Connection 1	Connection 2	Key
<b>19 950 1622</b> with rubber metal seal 100 MPa with 24/60° cone 200 MPa			1. G 1/4" male thread with 60° internal cone 2. G 1/4" male thread with 60° internal cone
<b>19 950 1623</b> 100 MPa			1. G 1/4" male thread with 60° internal cone 2. NPT 1/4" male thread
<b>19 950 1621</b> 100 MPa			1. G 1/4" male thread with 60° internal cone 2. R 1/4" male thread
<b>19 950 1603</b> 100 MPa			1. G 1/4" male thread with 60° internal cone 2. NPT 3/8" male thread
<b>19 950 1604</b> 100 MPa			1. G 1/4" male thread with 60° internal cone 2. R 3/8" male thread
<b>19 950 1602</b> 200 MPa			1. G 1/4" male thread with 60° internal cone 2. G 1/4" male thread with 120° external cone
<b>19 950 1605</b> 200 MPa			1. G 1/4" male thread with 60° internal cone 2. 9/16"-18 UNF thread with 60° external cone
<b>19 950 1606</b> 200 MPa			1. G 1/4" male thread with 60° internal cone 2. 3/4"-16 UNF male thread with 60° external cone
<b>19 950 1607</b> 200 MPa			1. G 1/4" male thread with 60° internal cone 2. M16x1.5 male thread with 60° external cone

Thread connections are listed according to ISO Standards (see Page 23 for more information). All measurements are in mm (Dimension key, see page 25). Pressure conversion table, see page 24. Check with your local retailer for availability and prices.



Part No.	Max. Rec. Working pressure.	Connection 1	Connection 2	Key
19 950 1608	200 MPa			1. G 1/4" male thread with 60° internal cone 2. M22x1.5 male thread with 60° external cone
19 950 0029	200 MPa			1. G1/4" male thread with 120° external cone 2. 9/16"-18 UNF male thread with 60° internal cone
19 950 1601	300 MPa			1. G 1/4" male thread with 120° external cone 2. G 1/4" male thread with 120° external cone
19 950 1611	200 MPa			1. G 1/4" male thread with 120° external cone 2. 3/4"-16 UNF male thread with 60° external cone
19 950 1610	300 MPa			1. G1/4" male thread with 120° external cone 2. M16x1.5 male thread with 60° external cone
19 950 1609	200 MPa			1. G 1/4" male thread with 120° external cone 2. M22x1.5 male thread with 60° external cone
19 950 0022	300 MPa			1. G 1/4" male thread with 120° external cone 2. 9/16"-18 UNF male thread with 60° external cone
19 950 1613	300 MPa			1. 9/16"-18 UNF male thread with 60° external cone 2. M16x1.5 male thread with 60° external cone
19 950 1612	300 MPa			1. M16x1.5 male thread with 60° external cone 2. M16x1.5 male thread with 60° external cone
19 950 1614	200 MPa			1. 9/16"-18 UNF male thread with 60° internal cone 2. M16x1.5 male thread with 60° external cone
19 950 0016	100 MPa			G 1/8" male, fully threaded
19 950 0015	100 MPa			G 1/4" male, fully threaded
19 950 1600	300 MPa			1. G 1/4" male thread with 120° external cone 2. -
Rubber metal seals				
Tredo		Part number	Size	Max. working pressure
		19 950 0061	1/8"	100 MPa
		19 950 0062	1/4"	100 MPa
		19 950 0064	3/8"	100 MPa
		High strength		
		19 950 0083	1/4"	150 MPa Bursting pressure 260 MPa
USIT		19 950 0084	1/4"	100 MPa
Copper washer		09 950 4600	1/4"	200 MPa

Thread connections are listed according to ISO Standards (see Page 23 for more information). All measurements are in mm (Dimension key, see page 25). Pressure conversion table, see page 24. Check with your local retailer for availability and prices.

# Series 950. Porting blocks 300 MPa.

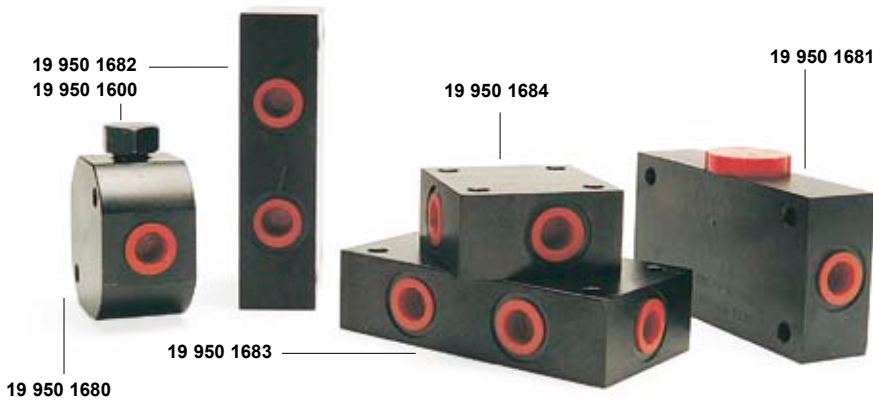

CEJN's porting blocks make it possible to utilise/connect several hydraulic lines from a single pump to numerous tools as well as the possibility of connecting a pressure gauge. The blocks are available in five different sizes and designs with a varying number of ports, see the product table for data on respective blocks. Five different blocks all in black-zinc plated steel. Flow diameter: 5 mm (3/16").



	Part No.	Connection	Max. Working pressure.
PORTING BLOCKS	19 950 1680 4-way distribution block	G 1/4" female thread Seal with 120° sealing cone or rubber metal seal Supplied with one blind plug	300 MPa (100 MPa with rubber metal seal)
	19 950 1681 3-way gauge block	G 1/4" female thread Seal with 120° sealing cone or rubber metal seal  Gauge connection G 1/2"  Supplied with sealing washer	200 MPa (100 MPa with rubber metal seal)
	19 950 1682 3-way distribution block	G 1/4" female thread. Seal with 120° sealing cone or rubber metal seal	300 MPa (100 MPa with rubber metal seal)
	19 950 1683 5-way distribution block	G 1/4" female thread. Seal with 120° sealing cone or rubber metal seal	300 MPa (100 MPa with rubber metal seal)
	19 950 1684 2-way L-Block	G 1/4" female thread. Seal with 120° sealing cone or rubber metal seal	300 MPa (100 MPa with rubber metal seal)
	Blind plug	19 950 1600	G 1/4" male with 120° sealing cone (CMS)

Thread connections are listed according to ISO Standards (see Page 23 for more information). All measurements are in mm (Dimension key, see page 25). Pressure conversion table, see page 24. Check with your local retailer for availability and prices.

# Maintenance Advise - High Pressure Hydraulics Couplings and Nipples

**To guarantee a coupling's function, quality and lifetime, be sure to:**

- Dynamic load on nipple while disconnected may lead to seal damage causing leakage in disconnected position. Min. burst pressure on disconnected nipple is always the same as for the corresponding coupling.
- Never over-load the products. Check max.working pressure from catalogue (stated min. burst pressure is only valid for new products that have not been exposed to over-load, impacts, corrosion etc.)
- Keep the coupling and nipple clean and dry. Wipe them off before connection.
- Put the dust caps on when coupling and nipple are in disconnected position.
- In order to keep the dust caps clean, connect them together when coupling and nipple are in connected position.
- Avoid front-end impacts to the coupling and nipple.
- Check the sealing of the coupling and its moving parts regularly. If necessary, replace the coupling.
- Check the nipples on a regular basis. If they are heavily worn or marked, replace them. Worn nipples lead to greater wear on the couplings.
- Choose the proper connection for the application. Oversized connections cause unnecessary wear to the coupling.

## Technical Data – Measurement and Units

- Oil flow:** ..... The oil flow is measured within an accuracy of ±5%. The flow rate is valid at viscosity 30 cSt (30 mm<sup>2</sup>/s)
- Working pressure:** ..... Specified in MPa. The working pressure is often stipulated in the varying national and international standards for quick connect coupling.
- Burst pressure:** ..... Specified in MPa and measured with an accuracy of ±3%.
- Weight:** ..... The weight is measured in "g" (gram) as an average of 10 pcs.
- Temperature range:** ..... The temperature is measured in Celsius degrees within an accuracy of ±2°C (±3.6°F).

All technical data are measured according to CEJN standards. Contact CEJN for more detailed information.

## Sealing Materials

MATERIALS	FEATURES	TEMPERATURE RANGE	MEDIA
<b>NBR</b> (Nitrile rubber Buna-N)	Resistant to water, gasoline, grease, mineral oil, heat, and alkalis. Sensitive to ozone.	-30°C to +100°C (-22°F to +212°F)	Compressed air, oil, water
<b>FPM</b> (Fluorocarbon rubber Viton®)	Recommended for gasoline, oils, and acids. Weather-resistant. Not recommended for hot steam.	-15°C to +200°C (-5°F to +392°F)	Chemicals, hot air
<b>EPDM</b> (Ethylene Propylene rubber EPDM/EPM)	Suitable for hot water, alkalines, and acids. Not recommended for mineral oil.	-40°C to +150°C (-40°F to +302°F)	Water

Contact CEJN for more detailed information regarding sealing material and chemical compatibility with CEJN couplings.

## Table key for pages 9-22 – Sealing Method and Dimensions

- T - Rubber metal seal, see page 21.
- CMS - CEJN Metal Seal (120° cone)
- 1\* = High strength rubber metal seal 19 950 0083
- 2\* = Copper seal 09 950 4600

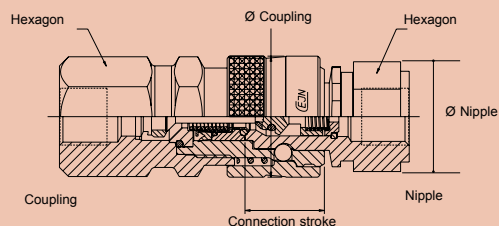



# Units, Conversion Tables, and Formulas

## Pressure

FROM	TO	MULTIPLY BY	EXAMPLE
atm (atmosphere)	bar	1.01325	1.1 atm x 1.01325 = 1.115 bar
atm	MPa	0.10132	1.1 atm x 0.10132 = 0.111 MPa
atm	PSI	14.696	1.1 atm x 14.696 = 16.166 PSI
bar	atm	0.98692	10 bar x 0.98692 = 9.8692 atm
bar	MPa	0.1	10 bar x 0.1 = 1.0 MPa
bar	PSI	14.504	10 bar x 14.504 = 145 PSI
MPa (megapascal)	atm	9.8692	10 MPa x 9.8692 = 98.692 atm
MPa	bar	10	10 MPa x 10 = 100 bar
MPa	PSI	145.0	10 MPa x 145.0 = 1450 PSI
PSI (pounds / square inch)	atm	0.068	100 PSI x 0.068 = 6.80 atm
PSI	bar	0.0689	100 PSI x 0.0689 = 6.89 bar
PSI	MPa	0.00689	100 PSI x 0.00689 = 0.689 MPa

## Flow

FROM	TO	MULTIPLY BY	EXAMPLE
CFM (cubic feet / minute)	l/min	28.32	100 CFM x 28.32 = 2832 l/min
CFM	l/s	0.472	100 CFM x 0.472 = 47.2 l/s
CFM	m <sup>3</sup> /h	1.699	100 CFM x 1.699 = 169.9 m <sup>3</sup> /h
l/min (liter / minute)	CFM	0.0353	100 l/min x 0.0353 = 3.5 CFM
l/min	l/s	0.0167	100 l/min x 0.0167 = 1.7 l/s
l/min	m <sup>3</sup> /h	0.06	100 l/min x 0.06 = 6 m <sup>3</sup> /h
l/s (liter / second)	CFM	2.119	10 l/s x 2.119 = 21.2 CFM
l/s	l/min	60	10 l/s x 60 = 600 l/min
l/s	m <sup>3</sup> /h	3.6	10 l/s x 3.6 = 36 m <sup>3</sup> /h
m <sup>3</sup> /h (cubic meter / hour)	CFM	0.5885	10 m <sup>3</sup> /h x 0.5885 = 5.885 CFM
m <sup>3</sup> /h	l/min	16.667	10 m <sup>3</sup> /h x 16.667 = 166.7 l/min
m <sup>3</sup> /h	l/s	0.2777	10 m <sup>3</sup> /h x 0.2777 = 2.777 l/s

## Volume

FROM	TO	MULTIPLY BY	EXAMPLE
ft <sup>3</sup> (cubic foot)	gl UK	6.228	10 ft <sup>3</sup> x 6.228 = 62.28 gl UK
ft <sup>3</sup>	gl U.S.	7.48	10 ft <sup>3</sup> x 7.48 = 74.8 gl U.S.
ft <sup>3</sup>	l	28.32	10 ft <sup>3</sup> x 28.32 = 283.2 l
ft <sup>3</sup>	m <sup>3</sup>	0.0283	10 ft <sup>3</sup> x 0.0283 = 0.283 m <sup>3</sup>
gl UK (gallon UK)	ft <sup>3</sup>	0.1605	10 gl UK x 0.1605 = 1.605 ft <sup>3</sup>
gl UK	gl U.S.	1.2009	10 gl UK x 1.2009 = 12.009 gl U.S.
gl UK	l	4.546	10 gl UK x 4.546 = 45.46 l
gl UK	m <sup>3</sup>	0.0045	10 gl UK x 0.0045 = 0.045 m <sup>3</sup>
gl U.S. (gallon U.S.)	ft <sup>3</sup>	0.1336	10 gl U.S. x 0.1336 = 1.336 ft <sup>3</sup>
gl U.S.	gl UK	0.8326	10 gl U.S. x 0.8326 = 8.326 gl UK
gl U.S.	l	3.785	10 gl U.S. x 3.785 = 37.85 l
gl U.S.	m <sup>3</sup>	0.0037	10 gl U.S. x 0.0037 = 0.037 m <sup>3</sup>
l (liter)	ft <sup>3</sup>	0.0353	100 l x 0.0353 = 3.53 ft <sup>3</sup>
l	gl UK	0.220	100 l x 0.220 = 22.0 gl UK
l	gl U.S.	0.264	100 l x 0.264 = 26.4 gl U.S.
l	m <sup>3</sup>	0.001	100 l x 0.001 = 0.1 m <sup>3</sup>
m <sup>3</sup> (cubic meter)	ft <sup>3</sup>	35.3	10 m <sup>3</sup> x 35.3 = 353 ft <sup>3</sup>
m <sup>3</sup>	gl UK	219.96	10 m <sup>3</sup> x 219.96 = 2199.6 gl UK
m <sup>3</sup>	gl U.S.	264.17	10 m <sup>3</sup> x 264.17 = 2641.7 gl U.S.
m <sup>3</sup>	l	1000	10 m <sup>3</sup> x 1000 = 10 000 l

## Force

FROM	TO	MULTIPLY BY	EXAMPLE
lbf (pound force)	kp	0.454	10 lbf x 0.454 = 4.54 kp
lbf	N	4.448	10 lbf x 4.448 = 44.48 N
kp (kilogram force)	lbf	2.205	10 kp x 2.205 = 22.05 lbf
kp	N	9.806	10 kp x 9.806 = 98.06 N
N (newton)	lbf	0.2248	10 N x 0.2248 = 2.25 lbf
N	kp	0.1020	10 N x 0.1020 = 1.02 kp

## Length

FROM	TO	MULTIPLY BY	EXAMPLE
ft (foot)	inch	12	10 ft x 12 = 120 inch
ft	m	0.3048	10 ft x 0.3048 = 3.048 m
ft	mm	304.8	10 ft x 304.8 = 3048 mm
inch	ft	0.0833	10 inch x 0.0833 = 0.833 ft
inch	m	0.0254	10 inch x 0.0254 = 0.254 m
inch	mm	25.4	10 inch x 25.4 = 254 mm
m (meter)	ft	3.28083	10 m x 3.28083 = 32.8083 ft
m	inch	39.3699	10 m x 39.3699 = 393.699 inch
m	mm	1000	10 m x 1000 = 10 000 mm
mm (millimeter)	ft	0.00328	10 mm x 0.00328 = 0.0328 ft
mm	inch	0.0393	10 mm x 0.0393 = 0.393 inch
mm	m	0.001	10 mm x 0.001 = 0.01 m

## Mass

FROM	TO	MULTIPLY BY	EXAMPLE
g (gram)	kg	0.001	10 g x 0.001 = 0.01 kg
g	lb	0.0022	10 g x 0.0022 = 0.022 lb
g	oz	0.0352	10 g x 0.0352 = 0.352 oz
kg (kilogram)	g	1000	10 kg x 1000 = 10 000 g
kg	lb	2.205	10 kg x 2.205 = 22.05 lb
kg	oz	35.273	10 kg x 35.273 = 352.73 oz
lb (pound)	g	453.9	10 lb x 453.9 = 4539 g
lb	kg	0.4539	10 lb x 0.4539 = 4.539 kg
lb	oz	16	10 lb x 16 = 160 oz
oz (ounce)	g	28.349	10 oz x 28.349 = 283.49 g
oz	kg	0.0283	10 oz x 0.0283 = 0.283 kg
oz	lb	0.0625	10 oz x 0.0625 = 0.625 lb

## Torque

FROM	TO	MULTIPLY BY	EXAMPLE
kpm (kilo pound meter)	lbfft	7.233	10 kpm x 7.233 = 72.33 lbfft
kpm	Nm	9.81	10 kpm x 9.81 = 98.1 Nm
lbfft (pound force foot)	Nm	1.356	10 kpm x 1.356 = 13.56 Nm
lbfft	Nm	0.1383	10 kpm x 0.1383 = 1.38 kpm
Nm (newton meter)	kpm	0.1020	10 Nm x 0.1020 = 1.02 kpm
Nm	lbfft	0.7376	10 Nm x 0.7376 = 7.38 lbfft

# Application Guide

APPLICATION EXAMPLE	115	115 Flat-Face	116	116 Flat-Face	125	135	218	230
Cylinders	X		X	X	X	X	X	X
Spreader	X						X	X
Presses	X						X	X
Puller	X						X	X
Nut runner	X		X	X	X	X	X	X
Bolt tensioner	X		X	X	X	X	X	X
Rescue tools	X	X					X	X
Torque tools	X	X					X	X
Cable cutters	X	X					X	X
Bearing pullers	X		X	X	X	X	X	X
Alignment benches	X						X	X
Hydrostatic testing	X	X	X	X	X	X	X	X
Clamping tool	X		X	X			X	X
Bending tools	X						X	X
Punches	X						X	X

# Connections and Thread Standards

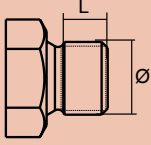
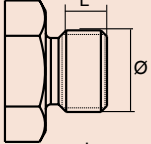
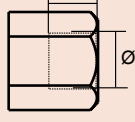
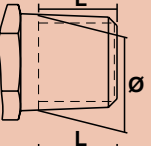
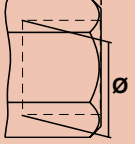
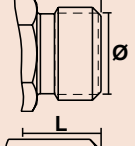
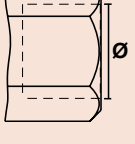
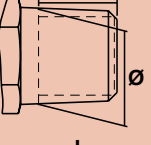
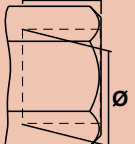
		Connection	Ø (mm)	L (mm)
<p><b>UNF thread connection</b> Unified threads according to ISO 68, ANSI B1.1</p> <p>Male:                    ie. 9/16"-18 UNF</p>		<p><b>Male thread</b> 9/16"-18 UNF 3/4"-16 UNF</p>	<p>14.15 18.89</p>	<p>9.28 13.08</p>
<p><b>Metric thread connection</b> Metric threads according to ISO 68/ISO 724</p> <p>Male and female:    ie. M16x1.5</p>	 	<p><b>Male thread</b> M16x1.5 M22x1.5</p> <p><b>Female thread</b> M16x1.5</p>	<p>15.85 21.85</p> <p>14.5</p>	<p>8.81 15.7</p> <p>9.0</p>
<p><b>R/Rc Thread Connection</b> Conical Pipe Thread Connection According to ISO 7/1 (Other common descriptions are BSPT, Kr)</p> <p>Male:                    ie. R 1/4" Female:                ie. Rp 1/4" (parallel)                               ie. Rc 1/4" (taper)</p>	 	<p><b>Male thread</b> R 1/8" R 1/4" R 3/8" R 1/2" R 3/4"</p> <p><b>Female thread</b> Rc 1/8" Rc 1/4" Rc 3/8" Rc 1/2" Rc 3/4"</p>	<p>10.2 13.6 17.2 21.7 27.1</p> <p>8.3 11.0 14.5 18.0 23.5</p>	<p>7.4 11.0 11.0 15.0 16.3</p> <p>7.4 11.0 11.4 15.0 16.3</p>
<p><b>G Thread Connection</b> Cylindrical Pipe Thread Connection According to ISO 228/1 (Other common descriptions are BSP, R)</p> <p>Male:                    ie. G 1/4" Female (ISO 1179):   ie. G 1/4"</p>	 	<p><b>Male thread</b> G 1/8" G 1/4" G 3/8" G 1/2" G 3/4"</p> <p><b>Female thread</b> G 1/8" G 1/4" G 3/8" G 1/2" G 3/4"</p>	<p>9.6 13.0 16.5 20.8 26.3</p> <p>8.75 11.8 15.25 19.0 24.5</p>	<p>8.0 10.0 10.0 12.0 12.0</p> <p>7.4 11.0 11.4 15.0 16.3</p>
<p><b>NPT Thread Connection</b> National Pipe Thread American standard according to ANSI/ASME B 1.20.1</p> <p>Male and female:    ie. 1/4" NPT</p>	 	<p><b>Male thread</b> NPT 1/8" NPT 1/4" NPT 3/8" NPT 1/2" NPT 3/4"</p> <p><b>Female thread</b> NPT 1/8" NPT 1/4" NPT 3/8" NPT 1/2" NPT 3/4"</p>	<p>10.5 14.0 17.5 21.8 27.1</p> <p>8.5 11.0 14.5 18.0 23.0</p>	<p>6.7 10.2 10.4 13.6 13.9</p> <p>6.9 10.0 10.3 13.6 14.1</p>



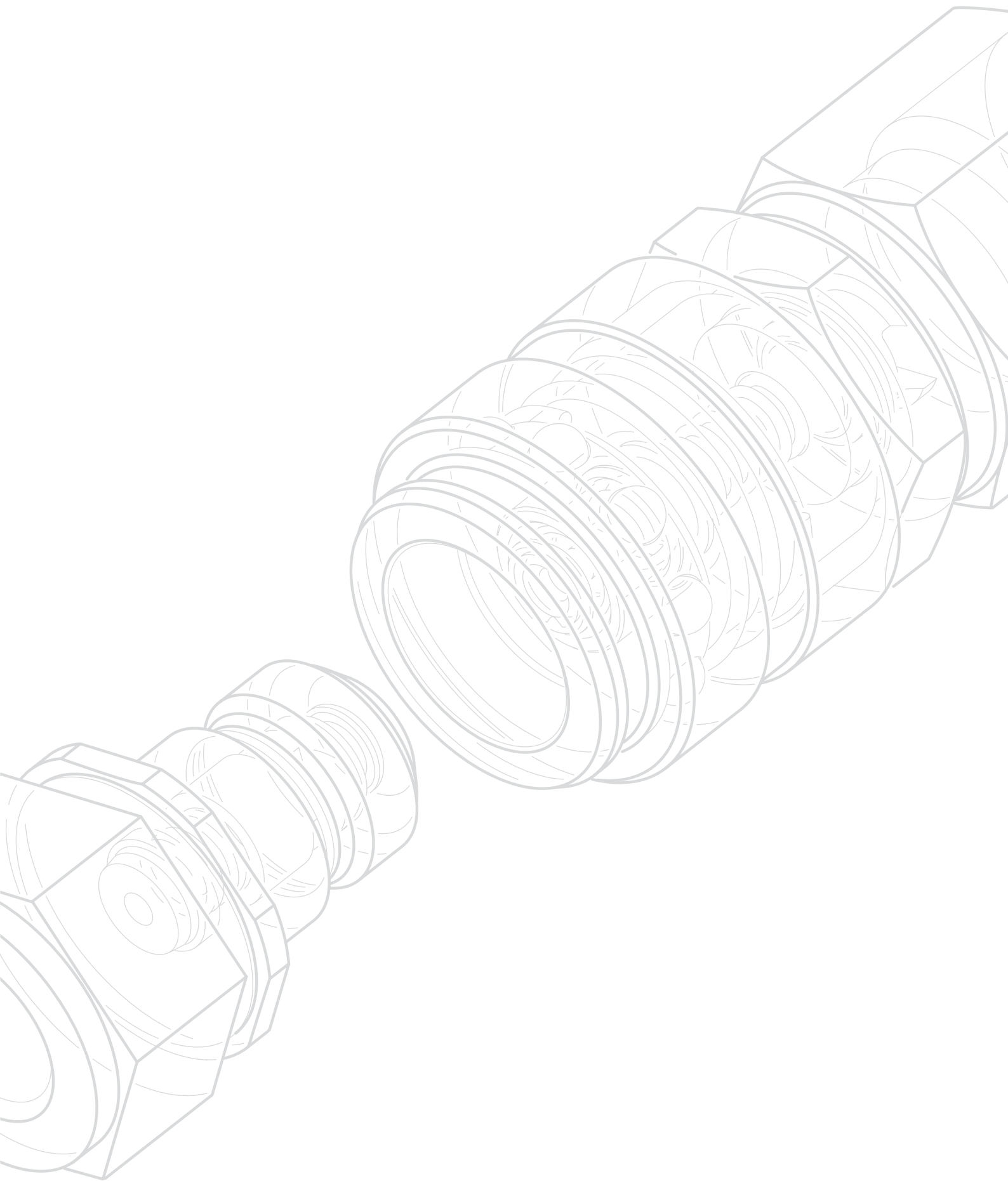

## **Other Products Available from CEJN**

*To obtain product information or product brochures, contact your nearest CEJN office or representative, or visit us on the Internet at – [www.cejn.com](http://www.cejn.com)*



*The Global*  
**Quick Connect Specialist**

